

# MINM-009



## LOWER BACK

**User Manual**

---





▲ Please carefully read this manual prior to assembling and using the machine. We assume that you have read it when you are using it.

▲ Please fill out the warranty card carefully and keep it with receipt and stub for after-sales service.

▲ This manual may be modified along with improvement of the machine and we'll not give further notice about it.

▲ This manual should be well kept so that you can read it at any time.

# CONTENTS

INSTRUCTIONS.....	1
STRUCTURE.....	3
PRODUCT INTRODUCTION.....	4
SPECIFICATIONS.....	5
ASSEMBLY TOOLS.....	5
PACKING LIST.....	6
ASSEMBLY INSTRUCTIONS.....	7
MUSCLE DIAGRAM.....	13
USAGE GUIDANCE.....	14
NOTICES.....	16
ROUTINE MAINTENANCE.....	17

# INSTRUCTIONS

1. This equipment is only intended for use in organizations with training areas, sport associations, clubs and educational establishments.
2. The max user weight is 150kg (330pound). (NOTICE)
3. It must be used under the supervision of a coach in case of any accident or damage to the machine. (WARNING)
4. Children under 12 must not use the machine in case of severe injuries or even physical disability while cardiac patients are prohibited from using the machine. (DANGER)
5. Please stop immediately and go to the doctor if you feel dizziness, nausea or any other discomfort. (WARNING)
6. It must be located stably on an even floor in case of slips during use. Enough clearance must be kept for safety; generally, a distance of 4 feet (1.2m) is between the user and the center of the space around,
7. Select appropriate weight stack and position (for instance, adjust saddle height) prior to exercise.
8. Check if all set screws are tightened and whether handrails are well fastened prior to use. Otherwise, using it is prohibited in case of any accident. (WARNING)
9. Adjust steel cables to proper lengths, and make sure they are well fastened and move smoothly without any twist. Regular inspection must be implemented to avoid any error. If any problem, it must be solved by professionals instantly. For any fault with weight stacks, guide rod or any other

mechanical part, please contact professional to fix it immediately in case of accident as weight stacks may fall off. (WARNING)

10. Please wear suitable dresses and shoes during exercise. (NOTICE)

11. 5 to 10 minutes of warm-up exercise must be taken prior to exercise on the machine.

12. Injury to health may result from incorrect or excessive training, please select proper exercise duration and suitable load, and have workout in correct way. (NOTICE)

13. No touching steel cables or any moving parts during exercise in case of injury to fingers. (DANGER)

14. Do not return to the starting position too quickly in case of any damage to the weight stacks, instead, you must slow down when getting near. (WARNING)

15. The machine must be used in dry room in case of any damage.

16. Do not have movements beyond the machine's function. (WARNING)

17. Any adjustment to the unit which may interfere with users' exercise is not allowed to be made. (DANGER)

# STRUCTURE



# PRODUCT INTRODUCTION

Target muscles: Erector Spinae.

Welded quality flat oval pipes and steel bring the unit scientific structure, simplified and elegant look as well as ergonomic movement trajectory.

Shroud assembly: It perfectly protects users from weight stacks and enhances usage safety.

Junctions: High-end bearings used for junctions bring smoother movements.

Handles: Reasonably designed handles with high degrees of comfort bring smoother movements.

Shroud: Durable shroud is made of strengthened ABS with one-step forming technology.

Paint: Electrostatic coating applied in automobile manufacture is used to retain its beauty permanently without fading.

Frame: Quality drum shaped pipes (60\*120\*≥2.5T/Q195) are well welded and never deform.

Cushion: One-step PU foaming technology gives the cushion ergonomic feature and appropriate softness.

Pulley: Safe and durable pulleys are made of superb aluminum alloy with casting technology.

Steel cables: Durable steel cables made according to 6\*19+1 standard (Twist 6 cables which are constituted of 19 steel ropes around a main steel rope.) bring better safety and durability.



# SPECIFICATIONS

Product dimension: 1165mm(L)×1260mm(W)×1680mm(H)

Weight stack: 80kg (standard); 80~130kg (optional)

User weight: <150kg

Unit weight: 232kg

## ASSEMBLY TOOLS

NO.	NAME	SPECIFICATION	QUANTITY
1	Screwdriver	Philips	1
2	Open-ended spanner	17-19	2
3	Socket wrench	19	1
4	Allen wrench	10mm	1
5	Allen wrench	6mm	1
6	Allen wrench	5mm	1
7	Allen wrench	4mm	1
8	Allen wrench	3mm	1

# PACKING LIST

NO.	NAME	QUANTITY
1	Main frame assembly	1
2	Cam	1
3	Press arm assembly	3
4	Upper connecting assembly	1
5	Lower connecting assembly	1
6	Saddle assembly	1
7	Cushion	1
8	Back pad	1
9	Pedal	1
10	Guide rod for weight stacks	2
11	Shroud assembly	1
12	Hardware tools kit	1
13	Water bottle holder	1
14	Foam roller	1

# ASSEMBLY INSTRUCTIONS

1. Due to the big size of the unit, please assemble it in a space which is big enough.
2. Open the carton, remove all packing materials and take out the parts, classify them and tidily put them on vacant floor.
3. Check if all parts are there according to PACKING LIST.
4. It requires at least two persons.
5. Assemble shroud

(1) Dismantle front and rear shrouds; put them in safe area (No scratching or crashing!). (Picture A)

A

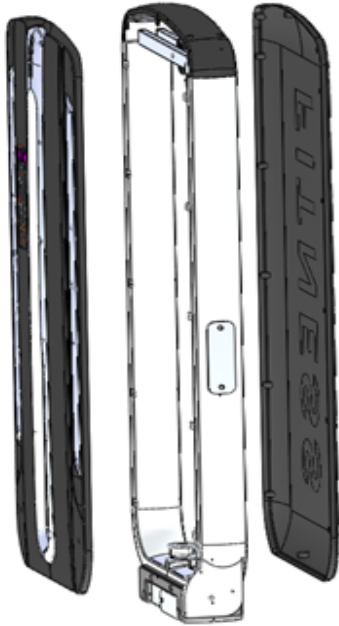

(2) Assemble weight stack: Insert the two guide rods into the two attachment holes on lower part of shrouds and pass them through shock pads; assemble weight stack one by one. (Picture B)

B



(3) Assemble weight stack on the top. (Picture C)

C



(4) Put circlips on upper parts of guide rods in right positions; fix guide rods. (Picture D)

D

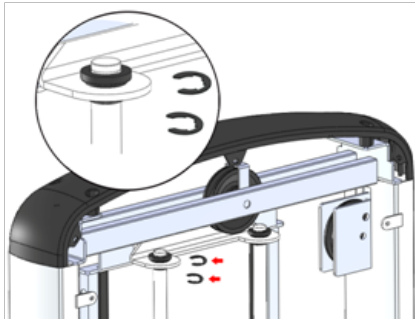

(5) Pass steel cable through cord lock; fix the cable. (Picture E and Picture F)

① Tighten the 3 screws as much as possible.

② Tighten threaded casing pipe by twisting it over 10 laps.

③ Fasten hex check nut.

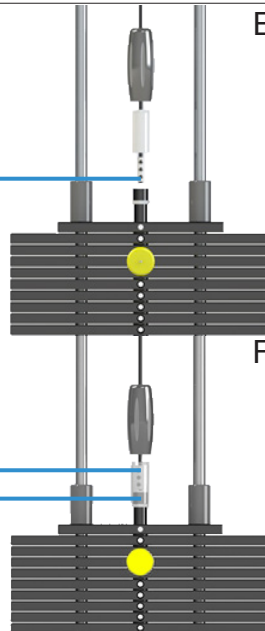

(6) Distribute steel cables according to Picture G.

G

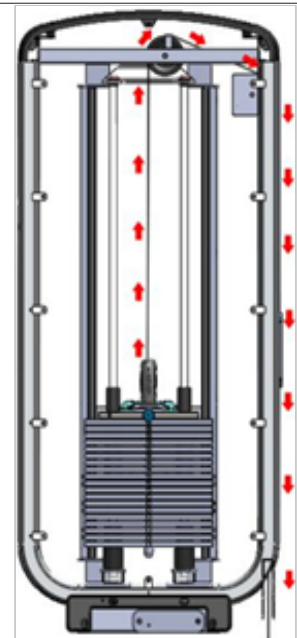

(7) Assemble water bottle holder. Check if all pulleys can move smoothly. (Picture H.)

H



(8) Assemble front shroud and counter; connect counter cables. (Picture I.)

I



(9) Assemble rear shroud. (Picture J.)

J



## 6. Assemble frame

(1) Put shroud which has been assembled in the area where the machine will be used.  
Check whether all the other parts are there according to the right diagram; remove packing materials and place them tidily. Assemble frame and attach fixing plate for upper and lower connecting&supporting assemblies to shroud with fastening screws as the diagram shows.

(2) Attach press arm assembly to shroud, and tighten all set screws. Fix steel cables and adjust them so they can move smoothly without any twist or slack.

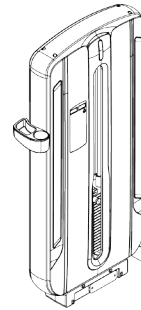

PLUG-IN UNIT	PART NAME	SPEC.	QTY.
AC1	Main frame		1
AE1	Upper connecting assembly		1
AE2	Lower connecting assembly		1
AE3	Cam		1
	Deep groove ball bearing	6202	2
	Bearing (Ø60, flat) cap	Ø59.4*15	1
	Hexagon socket head cap screw	M12*25	8
	Flat washer	12	8
	Hexagon socket head cap screw	M8*20	1

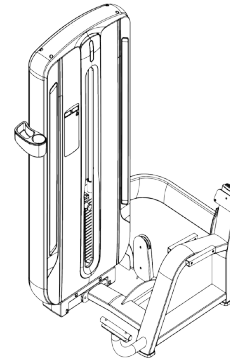
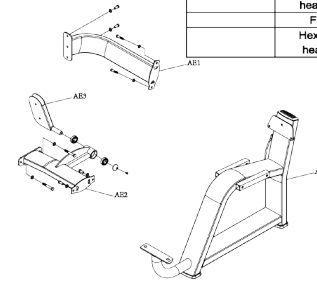

PLUG-IN UNIT	PART NAME	SPEC.	QTY.
AD1	Press arm		1
AD2	Press arm		1
AD3	Press arm		1
AD4	Cam		1
	Deep groove ball bearing	6005	2
	Bearing (Ø60, flat) cap	Ø59.4*15	2
	Hexagon socket head cap screw	M8*20	2
	Set screw	M8*16	2
	Counter weight	Ø135*100	1
	Deep groove ball bearing	6006	2

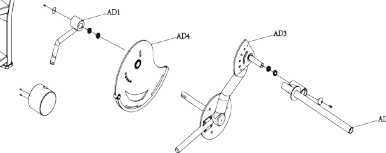

(3) Get steel cables distributed as the right diagram shows.

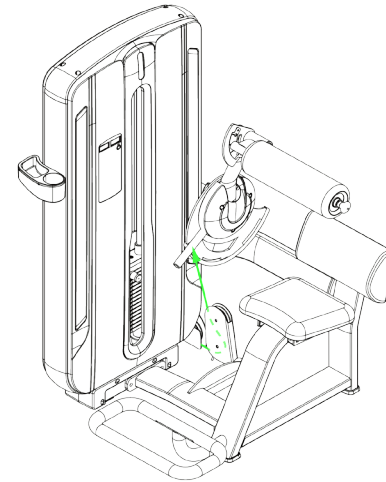

(4) Attach cushion, back pad, foam roller and pedal to frame.

(5) Recheck all junctions and tighten all loose screws in case of slack.

(6) Finally, a trial must be taken by professional to assure that it's correctly assembled.

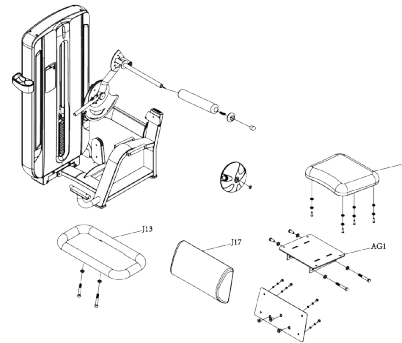

PLUG-IN UNIT	PART NAME	SPEC.	QTY.
AG1	Saddle assembly		1
H1	Cushion		1
J17	Back pad		1
J13	Pedal		1
	Foam roller	Ø140*480	1
	Handle spring	Ø15.2*120	1
	Front end of lever	Ø24*22.5	1
	Shield		1
	Foam roller cap (with hole)	Ø80*31	1
	Hexagon socket button head screw	M8*25	8
	Hexagon socket countersunk head screw	M10*25	3
	Hexagon socket button head screw	M8*25	12
	Flat washer	8	12
	Spring washer	8	12
	Hexagon socket head cap screw	M16*25	2



# MUSCLE DIAGRAM

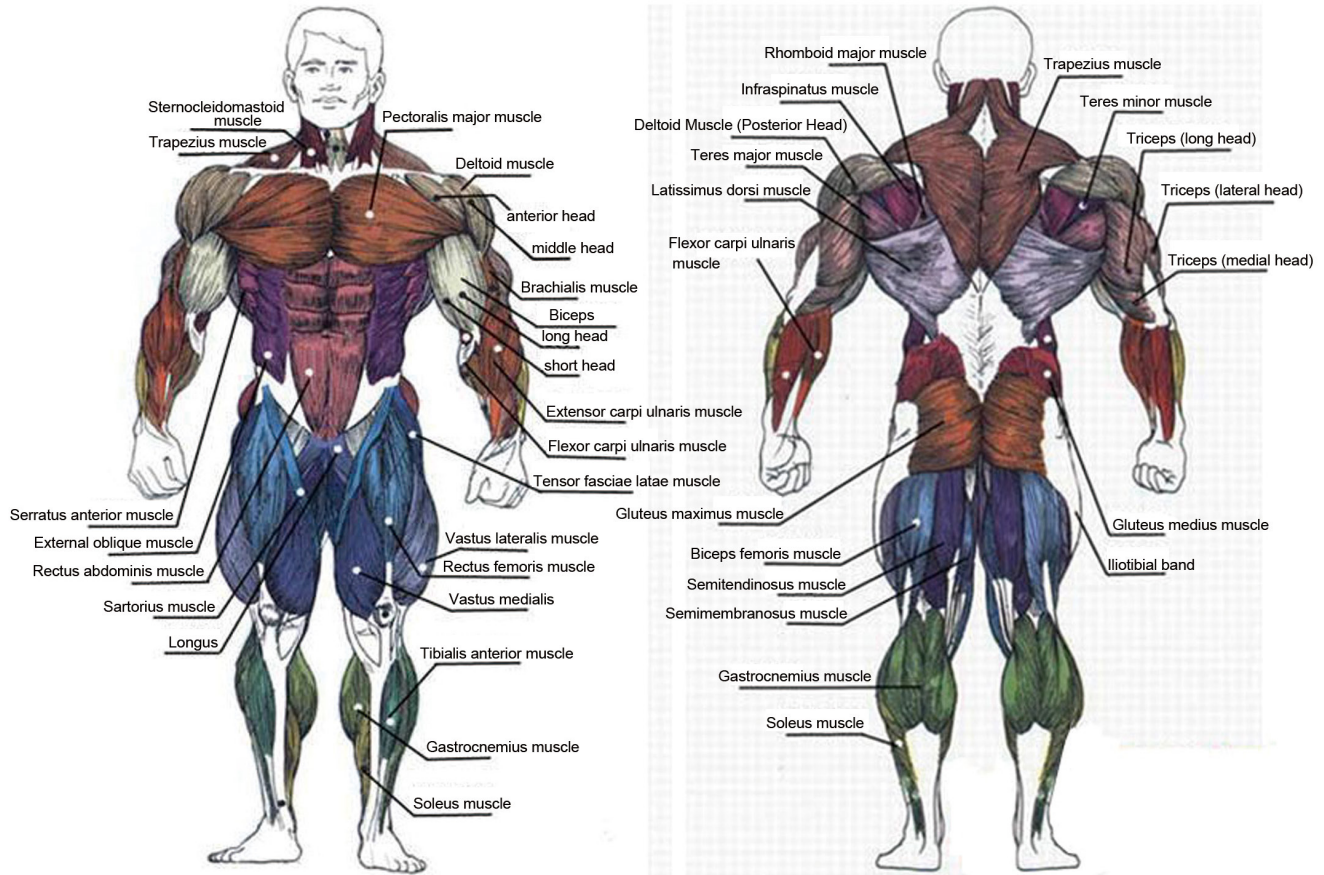

# USAGE GUIDANCE

## Instructions

Insert selector pin into weight stack at a suitable resistance level. Pull out the knob on the end of foam roller; adjust the roller so it's positioned comfortably against your upper back. Now sit down. Place your feet firmly on the pedal. Adjust foam roller with the yellow lever on your right to the angle which makes you able to lean forward. Please consult a coach if you are unsure on how to use this machine or experience any sharp pain during the exercise.

## Exercise Movement

Flex your upper body backwards in a smooth, controlled motion. Take care not to overextend your back. Pause for a moment and slowly return to the starting position. Repeat the movement.

Start

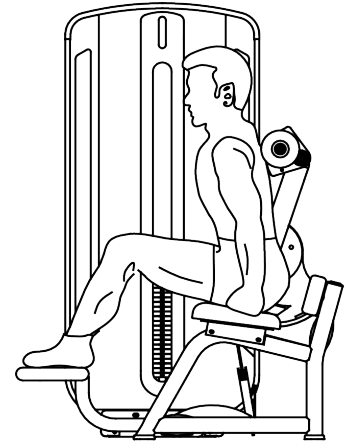

FINISH

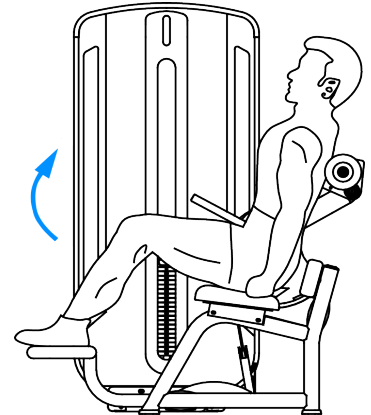

# Target Muscles

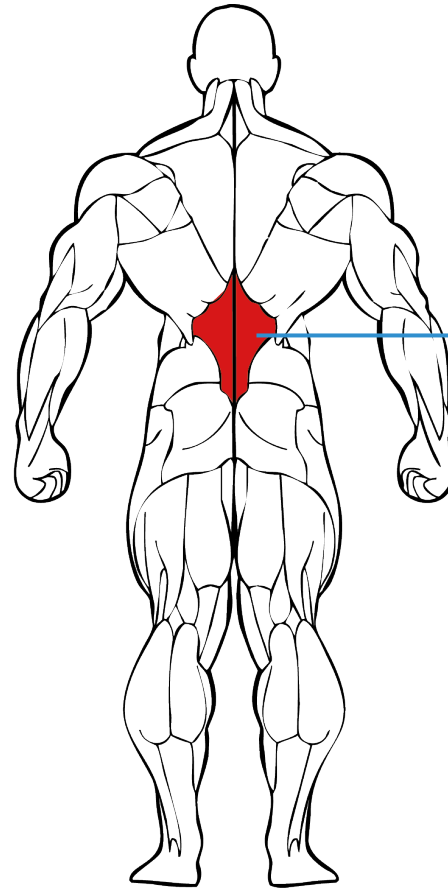
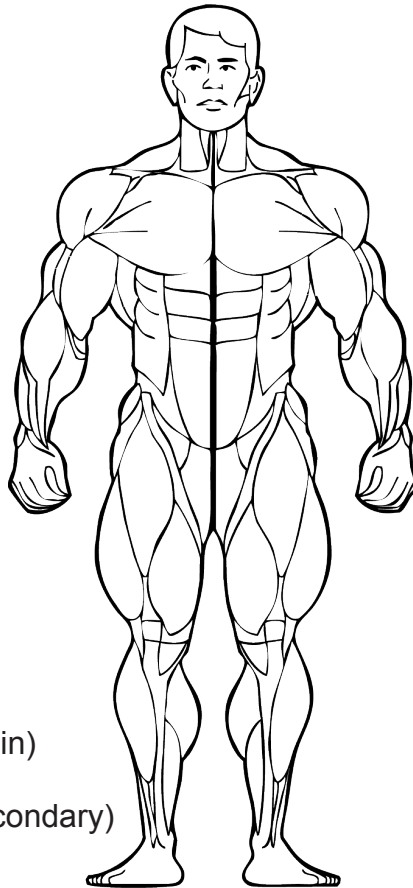

Erector Spinae

■ Target muscle (main)

■ Target muscle (secondary)

# NOTICES

1. 5~10 minutes of warm-up must be taken prior to having exercise on this machine. Record the time while having free exercise which aims to active the joints in case of injury to them during training.
2. Inspection must be carried out prior to using the machine. For any potential problem, please contact the staff immediately. Do not use it before it's assured that it can operate correctly.
3. Do not use the machine if there's a sign on it that tells there's problem with it.
4. Please take much food which contains protein, vegetables and fruits. Have a meal 40min prior to the exercise and another meal 30min after it. A small amount of water can be taken during exercise.
5. Inhale when move with strength; exhale when relax. Adjust breath according to movements.
6. The next workout for same muscle must be taken after at least 48 hours of rest.
7. Exercise load should be selected according to personal condition. Excessive weight must not be taken in case of injury to muscles. The training must be proceeded in an orderly way and step by step. It is normal to feel slight pain in the muscles during the first workout.

# ROUTINE MAINTAINANCE

## 1. Daily Inspection

Clean and inspect machine frame everyday; clean all decorative parts on it; check steel cables and the terminals to see if there's abrasion.

Clean decorative parts and machine frame with neutral soapy water, remove dirt, oil stain and sweat on the surfaces and air dry them completely. Inspect the frame and see if there's rupture, rustiness or any other damage. Make sure that welding points are fixed and fastening parts are correctly tightened. Fastening parts may get loose during usage; therefore, please check whether all of them, like nuts, bolts, screws are well fixed and correctly assembled. Tighten loose ones and replace damaged ones immediately. The machine can only be put into use after being repaired.

Regular inspections of steel cables, pulleys, fastening parts and other accessories must be carried out. If any obvious abrasion of steel cable is found, please replace it with original one from manufacturer immediately. Frequently used cables may not work due to abrasion, and then cause severe injuries to users. Hence, daily inspection of cables and the terminals must be implemented. If any damage, replace them immediately. Check whether there's twist or abrasion, whether coating and terminals are damaged. Special attention must be paid to the terminals of cables and the parts which are closed to pulleys. Damaged cables must be replaced immediately in case of injury to users. Characteristics of Obvious Damages (Picture 1)

(1) Internal cable is exposed; coating is scratched; there're pieces of coating in areas which pulley

contacts.

(2) Z-type twist or wave on cable.

(3) Tangled cables (Internal of cable may be damaged.).

(4) External part shrinks.

(5) External part gets inflated.

In addition, the following inspections must be carried out.

(1) Make sure that steel cables are correctly adjusted and fastened onto the top of weight stacks. Make sure that pulleys, terminals and assemblies are well connected and fastened, all the seven cable strands are connected to selector pin rod and set screws are well fastened.

(2) Wipe and clean all warning/instruction stickers. (Picture 2)

(3) After some time of use, steel cables may get loose due to normal stretch. It can be solved by adjusting round nut on weight stack on the top in time and fastening hexagon nut. If it fails, cut a small section of the cable and refasten it. (Picture 3)

Picture 1

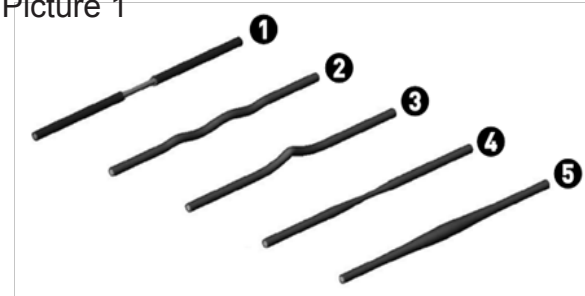

Picture 2

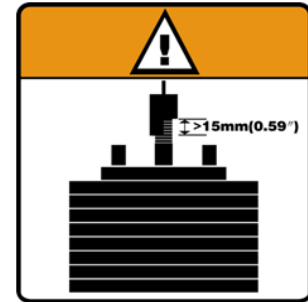

Picture 3

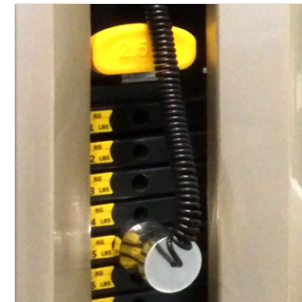

## 2. Weekly Inspection

Adjust and clean decorative parts; clean and lubricate cable rod terminal; clean and lubricate guide rods; inspect cables, connecting parts, and the tension; inspect cable accessories; inspect pulleys; inspect each weight stack and selector pin; inspect and lubricate bearings and bushings; inspect saddle adjustment system and test saddle adjustment system and saddle adapter pin.

(1) Clean ornamental coat with special detergent. Notice: Never use detergent which contains solvent, alcohol, ammonia or petroleum. It must be neutral detergent.

(2) Inspect cable rod terminal and assure that shoulder screw is well fastened. If there's noise, lubricate it with silicon oil. Spray the oil onto junctions between shell and bearing as shown in the following picture. Wipe them with cloth and remove excessive oil.

(3) Inspect exposed part of guide rod; keep it clean; remove dirt and oil stain on the rod with soft cloth. Notice: you can only inspect, clean and lubricate guide rod after dismantling shrouds.

(4) Spray silicon oil onto guide rod and leave a thin layer of the oil on it; or spray the oil onto cloth and then wipe guide rod with it. Never lubricate the rod when the machine is in use; the parts which are hidden in weight stacks can only be lubricated after the stacks are removed, otherwise, it will cause severe injuries.

Remarks: Do not use petroleum lubricant; it will lead to rapid accumulations of dirt and hair on weight stacks and may get the stacks stuck to each other.



- (5) Inspect and test steel cables and the junctions completely every week; inspect cable tension.
- (6) Inspect cables connections at weight stacks. Make sure less than 11/4 " (32mm) of most of the parts are exposed, so that the bolts can make at least 10 turns towards selector pin rod. Make adjustment according to this length, and fasten check nuts towards selector pin.
- (7) Inspect steel cables; pay special attention to parts which are closed to pulley and cams. Inspect junctions at cams; inspect bolt which passes through parts on the top of cam and assure that set screws are tightened.
- (8) Inspect steel cables; make sure all connections are firm and secure, tension is appropriate and steel cables are correctly fixed on the top of weight stack.
- (9) Inspect pulleys: check if there's abrasion, flaw, breach or deletion. Abrasion of pulley surface may lead to severe damage to steel cables. Therefore, abraded or damaged pulley must be replaced immediately. Make sure pulleys can revolve flexibly during usage and do not sway to left and right with big amplitude. Big amplitude indicates that fastening bolt or bearing is damaged; in this case, damaged bearing must be replaced immediately.
- (10) Inspect weight stacks and selector pin: check if there's burr or damage; wipe each stack and guide rod to remove dirt and dust. Make sure that selector pin can be inserted into each weight stack and stably retained there.
- (11) Inspect and lubricate bearings and casing pipes: it's suggested that a small amount of silicon oil should be sprayed onto copper casing pipe which is used for supporting shaft. Spray lubricant onto shaft and twist it several laps inside bushing; meanwhile, check whether the pipe is excessively



abraded or damaged.

### 3. Monthly Inspection

(1) Inspect main frame and press arm: lubricate the pin; inspect and lubricate lever for saddle; inspect all fastening parts.

(2) Inspect main frame and press arm: check if they are complete and work normally; check if there's cracking, coating damage or rustiness. Repair or replace the parts according to actual condition.

(3) Check if main frame is cracked. Pay special attention to welded junctions. If any crack, suspend the machine immediately and contact maintenance staff to repair it.

(4) Check if there's rust or coating damage on frame. If there's crack, wipe it gently with wet grainy cloth, dry emery cloth, or steel wire (fine thread) ball and then repair paint chips.

(5) Pull out the pin inside saddle; spray a small amount of silicon oil onto it; wipe it and remove excessive oil (as shown in the picture below).



Inspect if screws are tightened regularly.

Lubricate it regularly.

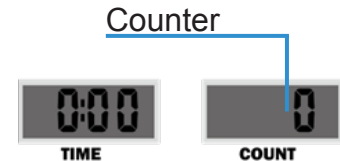

(6) Frequency and exercise duration can be displayed on counter during exercise. If not, battery needs to be replaced. Remove shroud, you can see an AAA battery, replace it with a new one. It's suggested that it gets replaced monthly.

#### 4. Annual Maintenance

(1) Dismantle shrouds and carry out necessary maintenance. It's suggested that one should dismantle weight stacks, clean and inspect them completely. Carefully take steel cables and guide rods off weight stacks; clean and inspect each stack; inspect guide rod sleeve. If any damaged part, replace it immediately. Clean guide rod and selector pin; assemble weight stacks and shrouds. We recommend that abraded or damaged cables get replaced during regular maintenance; and all cables should get replaced with new ones annually.

(2) Inspect and lubricate saddle adapter pin.



