



MBH 迈宝赫

Shandong MBH Fitness Co.,Ltd

Factory

Tel: +86-534-5919989|

Fax:+86-534-5065118

Address:Yinhe Industry Zone, Ninjin County, Dezhou, Shandong, China

Sales Office

Tel: +86 10 84928405

Fax: +86-10-84931216

Address: Room 501&502, Building C, Rui Pu Plaza, Hongjunying South Road, Chaoyang
District 100012, Beijing, China

Website: <http://www.mbhfit.com>

CABLE CROSSOVER

H-005

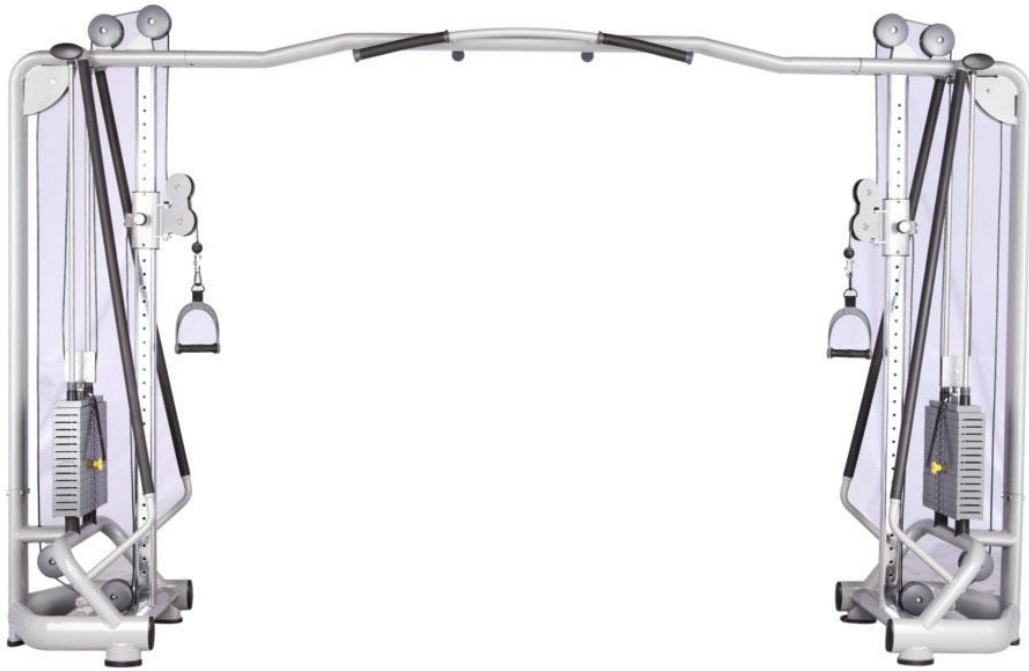

USER MANUAL

TABLE OF CONTENTS

1. INTRODUCTION.....	1
2. FEATURE.....	1
3. WARNING.....	1, 2
4. USAGE GUIDANCE.....	2, 3
5. NOTICE.....	3
6. MAINTENANCE.....	3
7. ASSEMBLY INSTRUCTION.....	4
8. CABLE.....	5
9. EXPLODED VIEW.....	6
10. ASSEMBLY TOOLS.....	7
11. ASSEMBLY STEPS.....	8, 9, 10

1. INTRODUCTION

Thank you for purchasing this unit.

For your health and safety, please make a reasonable training program with suitable weight stacks and correct postures under the coach's guidance before starting the workout. Please read this manual carefully before using the unit.

Please fill out the maintenance form carefully and keep it with receipt for after-sale service.

2. FEATURE

2.1 Quality steel pipes are applied for main frame.

2.2 High strength steel cables are used for transmission to enhance safety and durability.

2.3 Weight stacks are made of steel.

2.4 Fine bearings in rotating parts are reliable and bring no noise.

2.5 Quality leather makes transmission smoother.

3. WARNING

3.1 This training equipment is only intended for use in training areas of organizations such as sport associations, educational establishments, hotels, clubs and studios, where access and control are specifically regulated by professionals.

3.2 The unit can only be used by qualified members which are accepted strictly according to certain rules on items such as ages, occupations, health condition, etc.. Operations against the regulation are prohibited!

3.3 The unit must be used under the supervisions of a coach in case of any accident.

3.4 Children must be kept away from the unit in case of any serious injury which may cause permanent disability.

3.5 Injury to health may result from incorrect or excessive training, please consult the coach to select proper exercise method and suitable burden.

3.6 Please adjust load and position (e.g. seat adjustment) before using.

3.7 Please check if the bolt and handrail are working well before starting to use it.

3.8 For any fault in weight stacks, guiding rod or any other mechanical part, please contact the professional to fix it immediately in case of accident as the weight stacks may fall off.

3.9 Adjust the steel cables to proper length for smooth connection without any twist. Regular inspection must be held to avoid any error. For any problem, it must be solved by professionals instantly.

3.10 Do not return to the starting position too quickly in case of any damage to the weight stacks, instead, you must slow down when getting near.

3.11 No touching the steel cables or moving parts in use in case of jamming the hands!

- 3.12 Cardiac and children below 12 must not use the unit.
- 3.13 The training equipment is in compliance with EN 957-2 class S (S=studio);
- 3.14 The max training weight is 150kg (330pound) while the max user weight is 150kg (330pound).
- 3.15 The machine should be located stably with a space of 2000mm×2000mm kept around.
- 3.16 The unit is firstly used in trainings for professionals and secondarily for fitness in residential community and companies.
- 3.17 Please stop immediately and go to the doctor if you have any discomfort such as dizziness, nausea, etc..
- 3.18 The unit must be assembled and fixed stably on flat ground to avoid any movement of the machine in use.
- 3.19 The machine shall only be used indoor and kept away from moisture.
- 3.20 Please wear suitable dresses and shoes in exercise.
- 3.21 A warm exercise of 5~10min must be taken before using the unit.
- 3.22 Movements beyond its function are not allowed to have on the unit.
- 3.23 Please exercise under instruction of professional coach.
- 3.24 Please check if the unit is well fastened before starting your workout.
- 3.25 Any adjustment to the unit which may interfere with the users' exercise is not allowed.

4. USAGE GUIDANCE

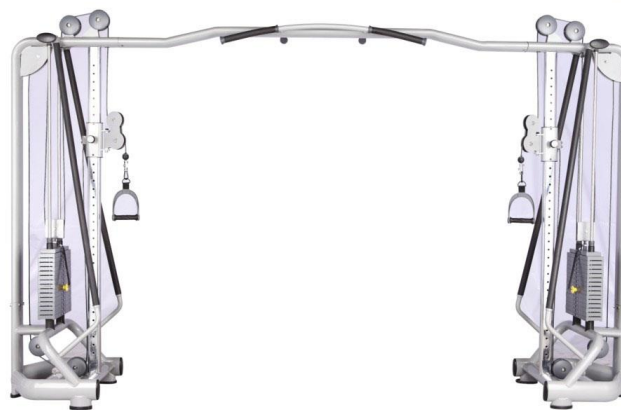

H-005 Cable Crossover

Targeted muscle: Pectorals, Dorsal Muscles, Arm Muscles
Dimension: 3700mm (L)×890mm(W)×2250 mm(H)
Weight :375kg

Usage Guidance:

- 4.1 Read all warnings and instructions prior to using the unit.
- 4.2 Insert selector pin into weight stack at suitable resistance level.
- 4.3 Contract arms naturally and grip left and right handles with both hands.
- 4.4 Stretch arms forward and slowly pull swing arms downward till both arms get fully stretched.
- 4.5 Keep the posture for a moment and then slowly return to starting position. Repeat the movements.
- 4.6 Pull-up can be taken by gripping handles on the top.

5. NOTICE

5.1 Warm exercise

Please have a warm exercise for 5~10 min which helps to activate joint muscles and avoid injury in exercise prior to start your workout. Mark the time while doing it.

5.2 Diet

Please take food which contains much protein, such as vegetables and fruits. Start the workout 40min after the meal. The next meal should be had 30min after stopping the workout while a small amount of water can be taken during exercise.

5.3 Breath

Inhale when move with strength; exhale when relax. Adjust breath according to movements.

5.4 Frequency

Enough rest is essential after exercise. The next stimulation on same muscle must be taken in 48hours.

5.5 Load

Select suitable load according to personal condition. Excessive weight must not be taken in case of injury to muscles. The training must be proceeded in an orderly way and step by step. It is normal to feel slight pain in muscles in the first workout.

6. MAINTENANCE

6.1 For safety use of machines, regularly maintenance must be implemented.

Especially for the attrition parts, such as cable, pulley block and connection parts.

6.2 Special attention should be paid to easy worn parts.

6.3 Replace the damaged components immediately and stop using the machine until it is fixed.

6.4 Maintenance should be made as following instruction.

MAINTENANCE	DAILY	WEEKLY	QUATERLY
Inspection: jointing, pulley, weight stacks	√		
Cleaning: cushion, shroud	√		
Lubrication: parts that need to be lubricated			√
Check if the screws are loosen		√	
Lubrication: bearings			√

7. ASSEMBLY INSTRUCTION

The instruction is to make the assembly easier, please read it carefully:

- 7.1 Due to the big size of the unit, please find enough space before assembling.
- 7.2 Remove all the packing materials and put all the parts on the floor tidily.
- 7.3 Tighten the screws to avoid slack except for special requirement.
- 7.4 Assure that the unit gets assembled with all the parts according to the assembly steps.
- 7.5 It must be done by at least 2 persons.
- 7.6 Check whether all the parts are there according to the packing list.
- 7.7 Please adjust the four fastening screws on the first weight stack if the weight stack pin cannot be easily plugged.

8. CABLE

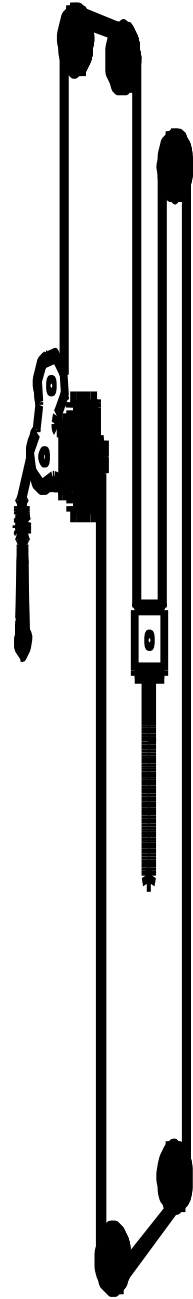
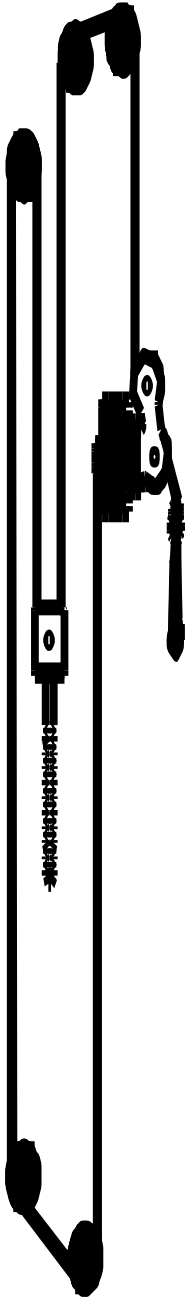

9. EXPLODED VIEW

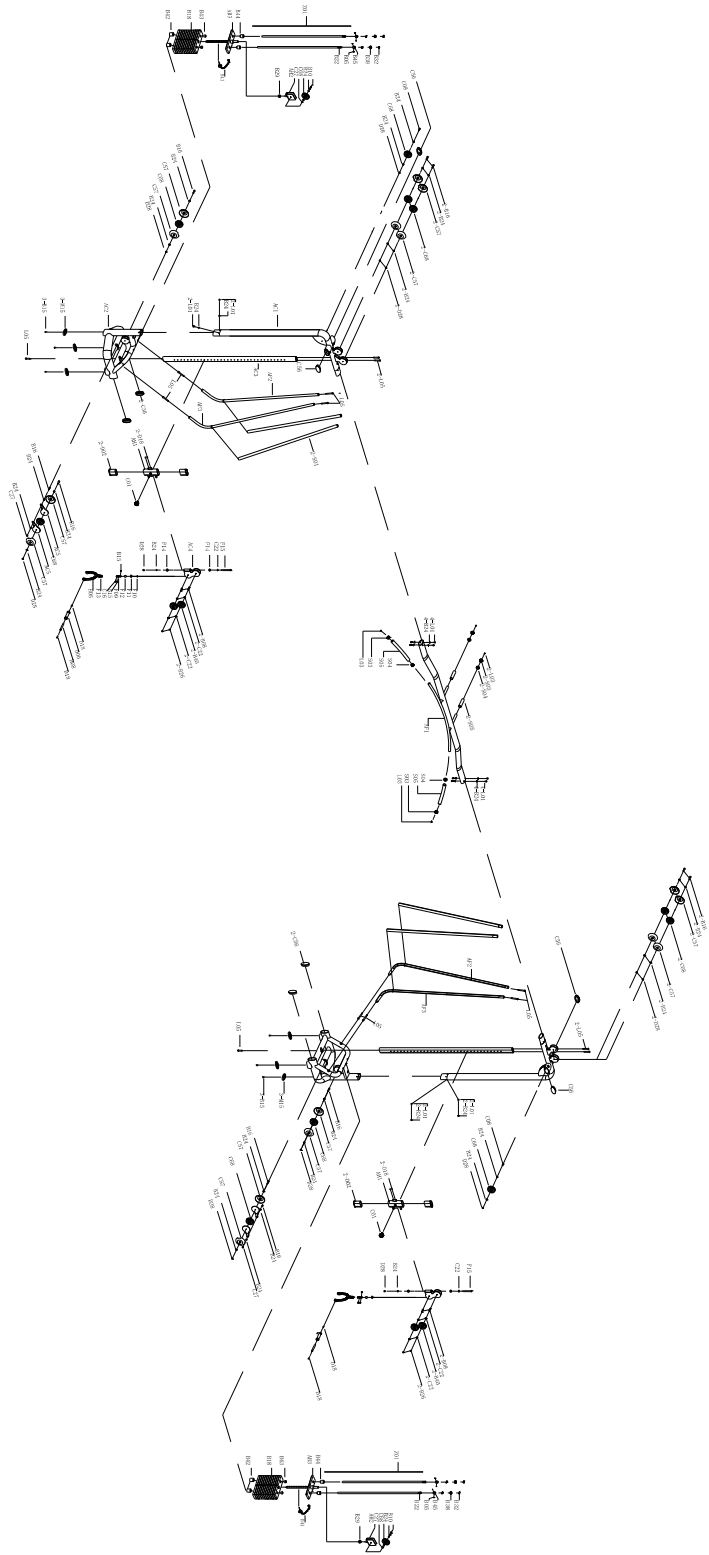

Exploded Picture

10. ASSEMBLY TOOLS

- (1) M6 Hex spanner
- (2) Cross screwdriver
- (3) 13-16 spanner--2 pieces
- (4) 22-24 spanner--2 pieces
- (5) M5 Hex spanner
- (6) M8 Hex spanner

11. ASSEMBLY STEPS

Step 1

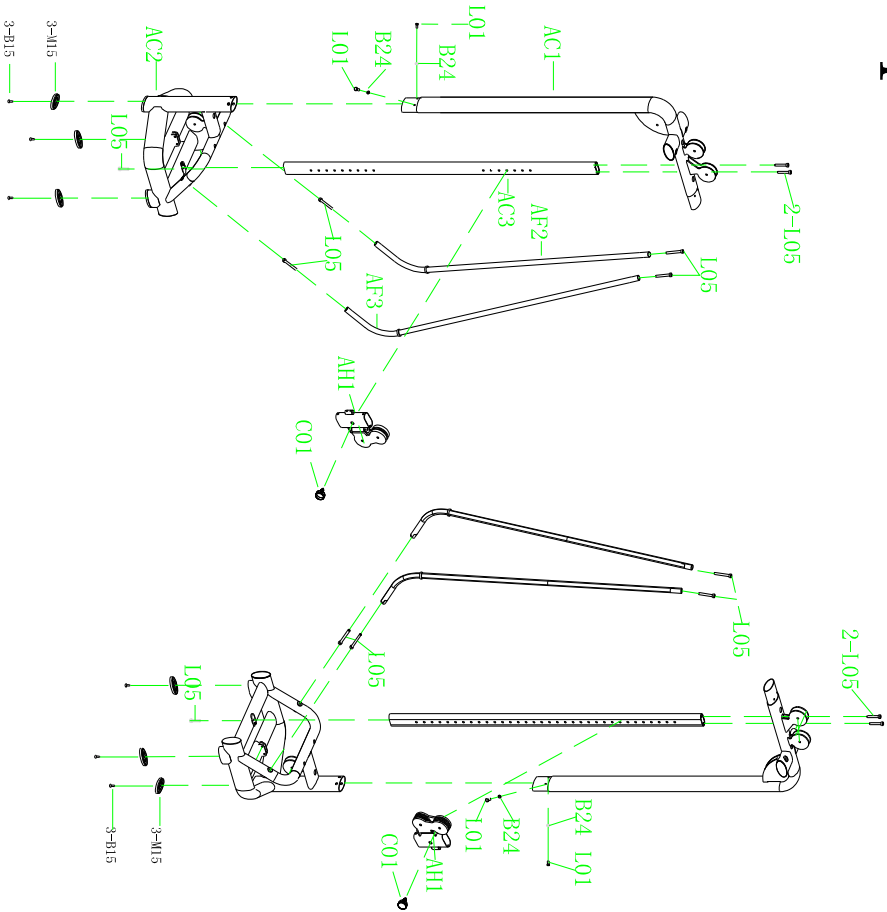

No.	name	size	quantity
AH1	poly bearing holder		2
AC1	welding assembly		2
AC2	wicket welding group		2
AC3	steel welding assembly		2
AF2	arm rest tube assembly		2
AF3	arm rest tube assembly		2
L05	inner hexagon screw	M10*7EL	14
C01	spring plug		2
B24	bracket	M10	4
L01	outer hexagon screw	M10*20L	4
M15	foot pad		6
B15	semicircle head inner hexagon screw	M8*1EL	6

Step 2

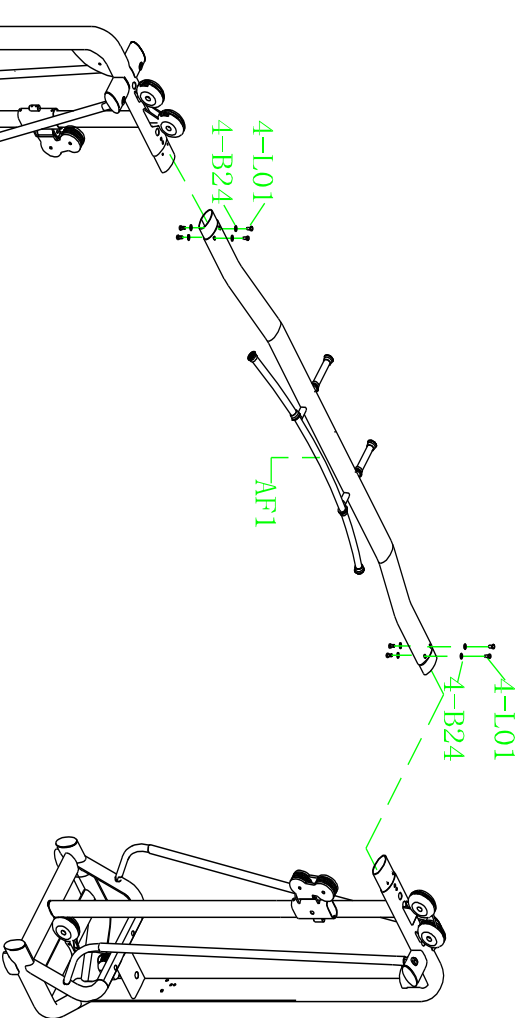

No.	name	size	quantity
AF1	horizontal rod welding assembly		1
L01	outer hexagon screw	M10x20L	8
B24	washer	M10	8

Step 3

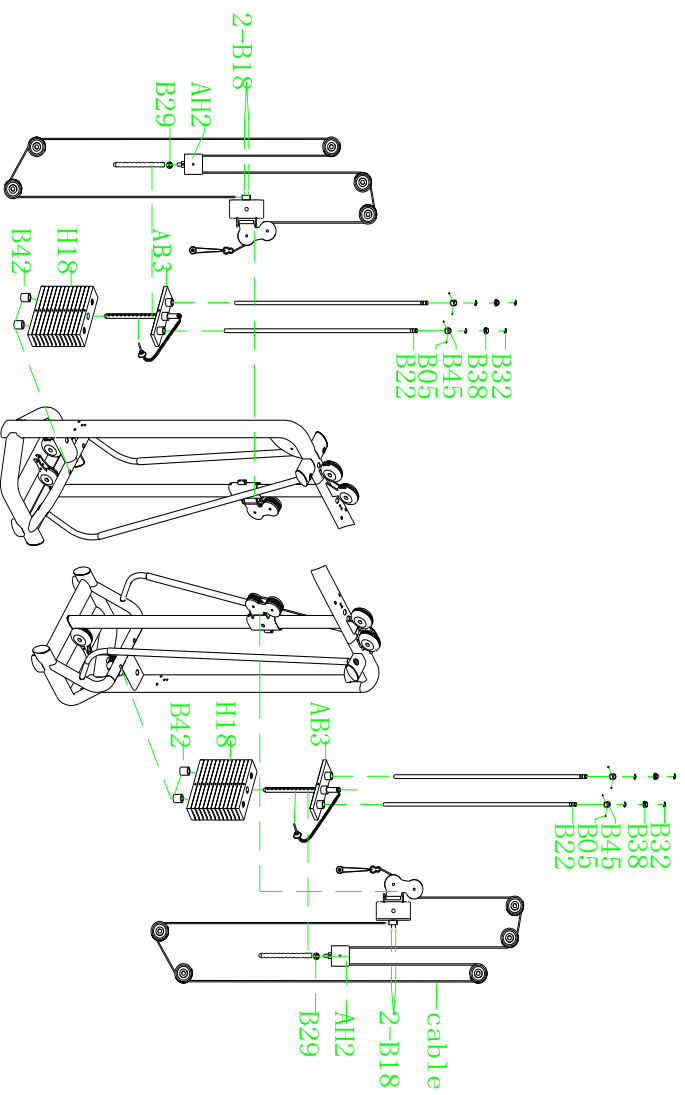

No.	name	size	quantity
AB3	first weight stack welding group		2
AH2	Pulley crane box welding group		2
B18	weight stack	280L*900*124	28
B05	jacking screws	M6*6L	8
D18	semi-circic head inner hexagon screw	M8*20L	4
B22	Guide bar	20*1.72	4
B29	nut	M16	2
B32	multi-function fix spring		8
B38	Inside plug for guide stem	20*25	4
B42	crash washer	50*60	4
B45	guide stem sliding sleeve		4
	cable	7.45mm	2